

aiwa

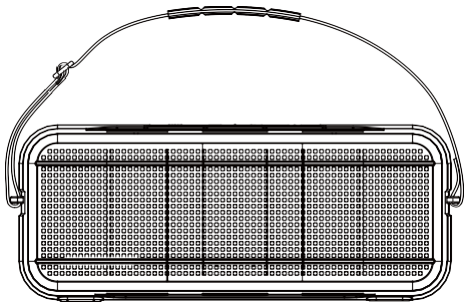

Portable Wireless Stereo Speaker

USER MANUAL

AIWA Katan Z

Package Includes

- 1 x Speaker
- 1 x Type-C charging Cable
- 1 x AUX Cable($\Phi 3.5\text{mm}$)
- 1 x User Manual

Over view of Speaker

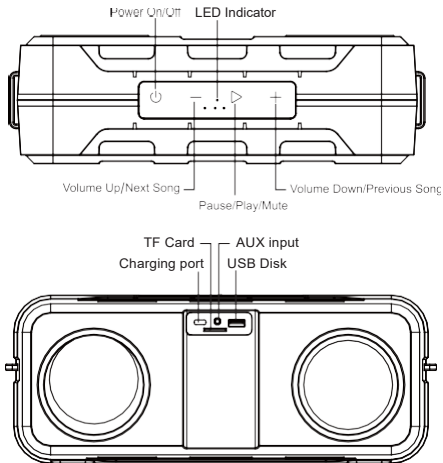

Charging

1. Before first time use, fully charge the built-in battery.
2. Connect the Type-C Cable (included) between
 - the  DC IN port on the speaker, and
 - a USB port on a computer or USB AC Adapter.

LED Indicator	Battery Status
Flash Red	Low battery(<10%)
Solid Red	Under Charging
Red light off	Full charged

Note: When the battery charge <3%, the speaker will power off automatically.

Power On

Press  button until hear a rising tone and LED indicator light on.

Power Off

Press  button until hear a descending tone and LED indicator light off.

Bluetooth connection

Make sure that the speaker is within 10 meters from your mobile device,

1. Press  button until hear a rising tone and LED indicator fast blinking White.
2. Go to the Bluetooth settings on your mobile device, search and select “AIWA Katan Z” from the list.
3. Once paired, the LED indicator turns Whiteblue.

Note:

- When power on, the speaker automatically reconnects to the last mobile device it was connected to. (The speaker can memorize maximum of 8 paired devices).
- The speaker will automatically shut down after 10 minutes in pairing mode if no devices are paired for power saving.

Music Control

Play/Pause



ClickV

Volume UP

ClickV

Volume Down

Click

Next track

Press and Hold

Previous track

Press and Hold

Switch Bluetooth mode/Aux-in mode.....Click

Speakerphone(in Bluetooth Connection)

Answer an incoming call.....Click

Reject an incoming call.....Press and Hold

End the current call.....Click

Redial last-called numberPress and Hold

Bluetooth Disconnection

Press “ ”, “ ” buttons simultaneously until LED

Indicator fast blinking White to disconnect the current connected device, and go into new Bluetooth-pairing mode



TWS (True Wireless Stereo) Function

The TWS technology enables you to use two speakers pairing via Bluetooth to create a wireless dual-channel system to deliver true stereo sound effect.

TWS connection operation

1. Place the two speakers near each other (the distance should not be over 10meters).
2. Power on the two speakers, double click the  button on one speaker as MASTER speaker (playback left channel), the LED indicator fast blinking White then the two speaker will pair to each other automatically (The other speaker will be as SLAVE speaker and playback right channel)
3. Once paired, the MASTER speaker LED indicator slow flash White.

Disconnect the TWS connection

Press “”; “” – button on one of the speaker simultaneously until LED Indicator fast blinking White to disconnect the TWS connection.

Listening music from external audio source

1. Power on the speaker.
2. Using the AUX Cable ($\varnothing 3.5\text{mm}$), connect your external device to AUX-in port on speaker.
3. It will automatically turn to AUX-in mode, the LED Indicator turns solid green.

Note: Under AUX-IN mode, skip songs and speakerphone function are not workable.

TF card reader (micro SD card)

Just simple insert your TF card into the port, the speaker can automatically turn to TF card reader mode, and play the MP3 music store in the card.

Music format: MP3, WAV,APE, FLAC, WMA

USB disk reader

insert your USB disk card into the port, the speaker can automatically turn to TF card reader mode, and play the MP3 music store in the card. Support

Music format: MP3, WAV,APE, FLAC, WMA

IPX5 Water-Resistant Feature

This Speaker is IPX5 Water-Resistant for rainfall, spills, or water jets, but do NOT submerge it in water or liquids.

IMPORTANT Note -To ensure the speaker is prepared to use for water-resistant,remove all the cable connections and close the port protection cover tightly.

Reset the speaker: If the function buttons without working disconnect the charging cable, place a small pin($\Phi < 3\text{mm}$) into the reset key and hold it for 2 seconds until the LED light off.

Specifications

- Bluetooth Version:5.0
- Support: A2DPV1.2;AVRCPV1.4, GAVDPV1.2; AVDTPV1.2;SPPV1.2;AVCTPV1.2
- Wireless work distance:10meters
- Rated Power:2x20W
- Driver Unit: 2 x ϕ 133mm(4 Ω ,2x20W)
- Frequency response:90Hz – 20KHz
- Signal-to-noise ratio:>75dB
- Battery type: Lithium-ion (5000mAh)
- DC input voltage/current: TYPE-C DC5V/2000MA
- Playtime: 6-8 hours (varies by volume level andcontent)
- Battery charge time: 3-4hours
- Dimensions:336*136*106mm
- Weight:2032g

Caution

- Keep the speaker and its accessories away from the reach of kids as they might cause a chokinghazard.
- Keep the speaker away fromfire,water,liquids,extreme heat,and strong magneticfields.
- Do NOT use this speaker at high volume for extended periods,as this may cause permanent hearing damage orloss.
- Do NOT drop or knock the speaker on hardsurfaces.
- Do NOT use chemicals or detergents to clean thespeaker
- Do NOT scrape the surface with sharpobjects.
- Do NOT make unauthorized alterations to thisproduct.

Troubleshooting

Cannot Power On

Charge the speaker and make sure it has enough battery

Cannot connect with the device

- Please check the following:
- The Bluetooth device supports A2DP profile
- The Speaker is within 10m from the device.
- The Speaker is in pairing mode, the LED indicator blinking blue and red.

No Sound

- Make sure the music volume is at audible level on both your device and speaker.
- Make sure your device is successfully paired with the speaker, the LED indicator turn solid blue.

Poor sound quality

Move the device closer to this Speaker or remove any obstacle between them.